



## General and Special Purpose Forensic Evidence Drying Cabinets

- Provides Environmentally Safe Processing, Drying and Storage of Evidence



Safe KEEPER<sup>®</sup> FDC-006XT



Product



Single



Duplex



Tri

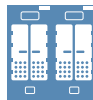

Quad



Single (Benchtop)



Single (Downflow)



Duplex (Downflow)



Schedule  
Contract # GS-07F5832P



## CONTENTS:

- Product Overview (p.2)
- Design Features (p.3)
- Performance & Selection (p.4)
- Filtration Technology (p.5)
- Product Information (p.7)
- Specifications (p.8)
- Options & Accessories (p.12)

## INTRODUCTION

Safe KEEPER® Series Forensic Evidence Drying Cabinets are designed to store, dry or otherwise process forensic evidence in the controlled environment of a tamper resistant compartment to maintain the chain of custody.

The industry leading [Multiplex™ Filtration System](#), combined with professional design and construction offer convenience and protect the safety of personnel during use, maintenance and decontamination of the cabinets.

## APPLICATIONS

Safe KEEPER Forensic Evidence Drying Cabinets provide cost-effective storage and containment for forensic evidence as it is dried by a constant flow of air. Air Science® ductless technology removes airborne pathogens, particulates, fumes and odors emitted by the contents. Using innovative filtration technology, the forensic evidence drying cabinet creates a safe work environment over the widest range of applications in the industry.

State and Federal Crime Laboratories \ Medical Examiners and Coroners \ Law Enforcement Agencies \ Hospital Emergency Rooms \ Drug Agencies



Deep into its second generation, Air Science embraces the diversity and cultural heritage of the founders and co-workers who are continuing a tradition of excellence. Demonstrating a commitment to adaptation, inclusion and quality output from a United States-based company with a domestic and global reach.

## KEY FEATURES

### General Purpose Series Drying Cabinets

- General Purpose Safe KEEPER cabinets are available in bench/desktop and floor-standing models. Select models are available with two, three or four independent drying chambers, each with its own filtration and control system.
- Most models are designed and configured for mobile use in uncontrolled environments.

### Special Purpose Series Drying Cabinets

- The Drug KEEPER™ series is designed for safe storage of confiscated hazardous chemicals and illegal drugs.
- The Safe SWAB horizontal airflow cabinet is useful for protecting biological evidence collected on swabs from external contaminants and personnel in the working environment.
- The Evidence TRANSPORTER™ is an "on-site" fabric chamber developed for transporting evidence from the field to the lab.

## DUCTLESS TECHNOLOGY

### The Eco-Friendly Choice

Advanced carbon filtration technology offers a safe, high performance alternative to conventional ducted cabinets for a broad range of applications.

**Environmental Benefits.** Air Science forensic evidence drying cabinets isolate and trap chemical vapors to prevent ecological impact through release into the environment.

**Versatile.** Each filtration system is selected for its specific application. Carbon filters are available in more than 14 configurations for use with vapors of organic solvents, acids, mercury and formaldehyde. HEPA/ULPA filters can be added for biological safety.

**Easy to Install.** The ductless Safe KEEPER Forensic Evidence Drying Cabinet is self-contained and does not require venting to the outside. Many units are portable and may be moved with minimal downtime and without filter changes. Set-up, operation and filter maintenance are straightforward.



Safe KEEPER FDC-002, shown with timed UV system

Safe SWAB FDC-001

**Energy Efficient.** Because filtered air is returned to the room, no demands are required of the facility HVAC capacity for make-up air.

**Cost Effective.** Facility ductwork, HVAC and construction costs are eliminated.

**Safe to Use.** Cabinet airflow and face velocity protect users from incidental exposures to fumes.

**Self-Testing.** (select models) Electronic airflow monitoring assures continuous safety. An electronic gas sensor monitors carbon filter performance.

## CONTENTS:

- Product Overview (p.2)
- Design Features (p.3)
- Performance & Selection (p.4)
- Filtration Technology (p.5)
- Product Information (p.7)
- Specifications (p.8)
- Options & Accessories (p.12)

# SafeKEEPER®

DESIGN FEATURES

# 3

## DESIGN FEATURES

- A. Filter I.D. Window:** A conveniently, strategically placed front cover window shows the installed filter part number and the installation date to encourage timely filter replacement.
- B. Filter Door Key:** Filter access key prevents unauthorized removal or accidental exposure to dirty filters.
- C. Control Panel:** Electronic controls and displays include switches for the blower and lights, an electronic hour counter and filter blockage alarm, all located on a convenient front surface panel.
- D. Hour Counter:** Assists in tracking evidence drying time.
- E. Internal Manual Speed Controller:** Authorized personnel may set the centrifugal fan motor speed as desired.
- F. Filter Blockage Alarm:** Continuously monitors filter loading and alerts user when service is needed.
- G. Dynamic Filtration Chamber:** The dynamic filter chamber prevents any possible leakage of contaminated air by pressurizing the fan plenum (positive air) and depressuring the filter compartment (negative air).
- H. Outside Sidewall Hose:** Connects to external water supply, located to avoid tripping hazard.
- I. Hanging Rod:** All General Purpose and Downflow models have removable stainless steel hanging rod with anti-slide cover.
- J. Drain:** Central 1.5" bottom drain with anti-siphon trap and strainer to capture contaminants in waste water stream.

- K. Push-Pull™ Shelving:** All General Purpose models have three perforated polypropylene Push-Pull shelves with drain channel that can be installed and removed with one hand and may be stored within or outside the cabinet; two included with Downflow unit.
- L. Drain Valve:** Manual open and close drain valve.
- M. Electrostatic Pre-Filter:** All pre-filters (doors and main) are changed quickly without tools and are of a standard size for simple stocking and ordering. Optional HEPA filter available.
- N. Doors:** Blue metal framed tempered glass doors with key lock and tamper proof seal provide improved security, stability and ease of cleaning.
- O. Built-in Containment Compartment:** Adheres to Occupational Safety and Health Administration (OSHA) Standards 29 CFR 1910.1030 regarding bloodborne pathogens.

## ADDITIONAL FEATURES

**Construction:** All models are available in polypropylene construction. See selection chart for specifications and dimensions. Available in 120V, 60HZ and 230V, 50Hz models.

**Optional UV Lamp:** Activated ultraviolet light creates light emission conditions known to provide secondary disinfection of the interior between cases to prevent cross contamination, ensuring integrity of the samples for DNA testing.



Safe KEEPER FDC-007D  
duplex model, shown open

## CONTENTS:

- Product Overview (p.2)
- Design Features (p.3)
- Performance & Selection (p.4)
- Filtration Technology (p.5)
- Product Information (p.7)
- Specifications (p.8)
- Options & Accessories (p.12)

Each Air Science Safe KEEPER Forensic Evidence Drying Cabinet includes features expressed through sound design and certified quality construction. Options and accessories add functional performance to meet specific applications.

## PERFORMANCE

The Air Science [Multiplex Filter](#) offers a range of options for high performance protection.

Multiplex filter configuration permits a customized combination of filter media for a broad range of chemical families and biological agents if required.

A high capacity air handling system delivers face velocity of 100 fpm.

## DESIGN

Professional quality Air Science general and special purpose forensic evidence drying cabinets comply with current technical and safety regulations. The cabinet frame and work surfaces, comprised of industrial components, are durable and chemically resistant.

The Air Science filter assembly is easy to access and easy to change, plus a unique filter clamping design eliminates bypass leakage outside the cabinet.

## SELECTION

General and special purpose forensic evidence drying cabinets are available in Safe KEEPER, Drug KEEPER, Safe SWAB and Evidence TRANSPORTER models, in a variety of sizes and configurations, totaling 60 different options.



Basic Control Panel



Advanced Control Panel



FSA/Autocal Control Panel

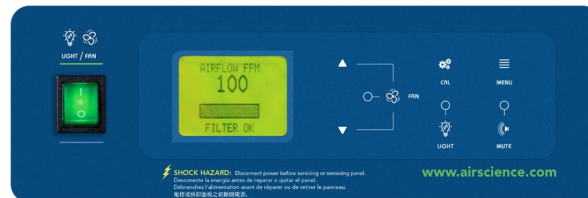

Monitair Control Panel

## RELIABILITY

Internal systems are isolated from fumes, extending product life.

## CONTROL

The **basic control panel** is standard on Drug KEEPER models and includes an On/Off switch and filter blockage alarm.

The **advanced control panel** is standard on Safe KEEPER models and includes an On/Off switch, filter blockage alarm and hour meter to aid in determining filter life.

The **optional FSA/Autocal controller** displays the airflow and offers limited detection of low concentrations of hydrocarbon, some gases and organic acids. Audio and visual alarms alert users to filter saturation and if the airflow reaches preset thresholds. An Hour Counter is also included.

The **optional Monitair microprocessor controller** monitors and displays cabinet operating parameters, airflow, containment and offers limited detection of low concentrations of hydrocarbon, some gases and organic acids. Audio and visual alerts if conditions become unsafe and are all displayed on a LCD screen.

**CONTENTS:**

- Product Overview (p.2)
- Design Features (p.3)
- Performance & Selection (p.4)
- Filtration Technology (p.5)
- Product Information (p.7)
- Specifications (p.8)
- Options & Accessories (p.12)

# multiple<sup>™</sup>



## FILTRATION

At the heart of the Safe KEEPER product line is innovative filtration technology. **The Multiplex Filtration System** consists of a pre-filter, main activated carbon or HEPA/ULPA filter and safety activated carbon or HEPA/ULPA filter. The system permits a customized combination of filter media and configuration for chemical and physical adsorption specific to each application need.

The Air Science **carbon filtration technique** is based on enhanced, activated carbon particle formulations from specially selected, naturally occurring raw material that is superior to wood or other organic sources. The carbon is treated to attain the proper porosity and aggregate surface area and to react with several ranges of aerosolized chemicals moved through the filter by an air handling blower.

## AIRFLOW

Safe KEEPER Forensic Evidence Drying Cabinets maintain a constant face velocity of 100 fpm in compliance with USA and international standards for safety and performance. Contaminated air is pulled through the Multiplex Filtration System; clean air is returned to the room.

**The main filters** are easy to replace and install. The filter clamps tightly against the filter gasket to prevent filter bypass and maintain filter integrity.

**⚠ The pre-filter** may be replaced while unit is in operation.

**The safety filter** is easy to replace and enhances filter capacity of the hood.

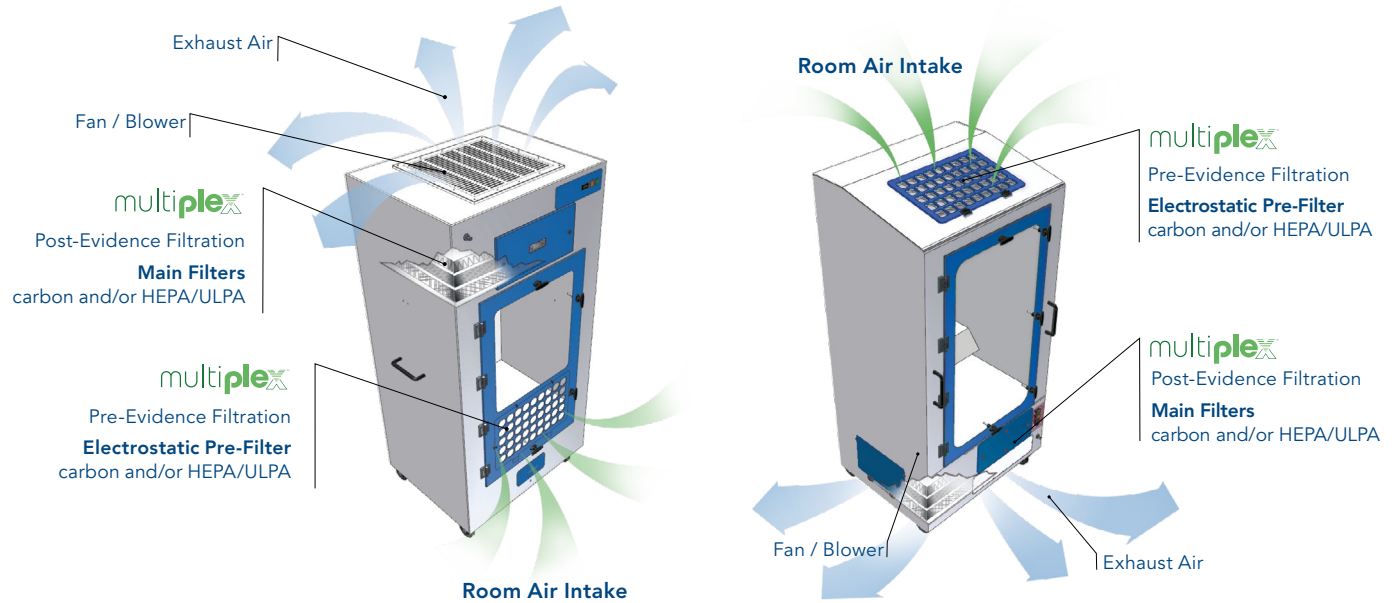

Through our partner company [Filtco Filters](#), Air Science is a single source supplier of all pre-filters, carbon filters and HEPA/ULPA filters used in our products.

























### FILTER SUMMARY\*

Formula	Description
GP Plus!	The most widely used filter in the range, primarily for solvent, organic and alcohol removal.
HEPA/UPLA	Powders and particulates.

\*Other formulas may be available.

## CONTENTS:

- Product Overview (p.2)
- Design Features (p.3)
- Performance & Selection (p.4)
- Filtration Technology (p.5)
- Product Information (p.7)
- Specifications (p.8)
- Options & Accessories (p.12)

MULTIPLEX™ FILTRATION GENERAL PURPOSE SERIES								SPECIAL PURPOSE SERIES					
Product Map	SafeKEEPER®							DrugKEEPER™		SafeSWAB™		EvidenceTRANSPORTER	
	Floor Mounted (all sizes)				Benchtop	Downflow		Floor Mounted		Benchtop	Desktop		Mobile
	Single	Duplex	Tri	Quad	Single	Single	Duplex	Single	Duplex	Single	Single	Single	Single
													
Nominal Width (inches)	30, 36, 39, 48, 60, 72, 96	48, 60, 72, 96	72	72	24, 30	36, 48, 60	36, 48, 60	34	64	34	18	7	28
Airflow													N/A
DNA Decontamination	optional	optional	optional	optional	optional	optional	optional	optional	optional	optional	optional	optional	N/A

## MULTIPLEX™ FILTRATION

### Door Filter, Pre-Evidence

Electrostatic	standard	standard	standard	standard	standard	standard	standard	standard	standard	standard	standard	standard	standard
HEPA / ULPA	optional	optional	optional	optional	optional	optional	optional	optional	optional	optional	optional	optional	optional

### Main Filters, Post-Evidence

First	electrostatic	electrostatic	electrostatic	electrostatic	electrostatic	electrostatic	electrostatic	electrostatic	electrostatic	electrostatic	HEPA / ULPA	HEPA / ULPA	HEPA / ULPA
Second, Biological	HEPA / ULPA	HEPA / ULPA	HEPA / ULPA	HEPA / ULPA	HEPA / ULPA	HEPA / ULPA	HEPA / ULPA	HEPA / ULPA	HEPA / ULPA	HEPA / ULPA	--	--	--
Third	carbon	carbon	carbon	carbon	carbon	carbon	carbon	carbon	carbon	carbon	--	--	--

### Exhaust, Back-up, Biological or Emergency Filtration

Carbon or HEPA / ULPA	optional	optional	optional	optional	optional	--	--	optional	optional	optional	--	--	--
-----------------------	----------	----------	----------	----------	----------	----	----	----------	----------	----------	----	----	----

### Construction

Finish	<... Polypropylene ...>												--
Electrical	<... 120V, 60Hz, or 230V, 50Hz voltages available. Specify when ordering. Other voltage options available. ...>												--
Monitoring	<... Filter Blockage ...>												--

## CONTENTS:

- Product Overview (p.2)
- Design Features (p.3)
- Performance & Selection (p.4)
- Filtration Technology (p.5)
- Product Information (p.7)
- Specifications (p.8)
- Options & Accessories (p.12)

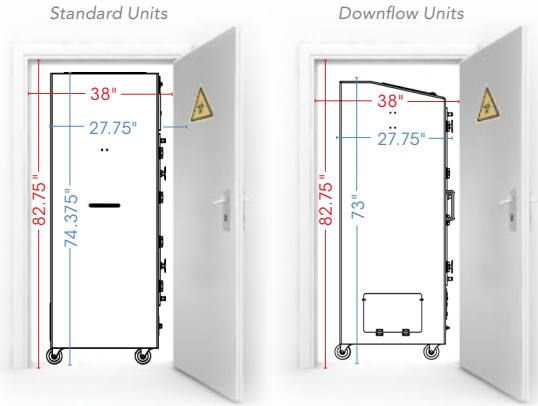

## DECONTAMINATION AND WASTE WATER REMOVAL FEATURES

### General Purpose Units, Including Downflow Models

- Outside sidewall hose connection to external water supply, located to avoid tripping hazard.
- Internal wash down spray hose for decontamination and cleaning.
- Central 1.5" bottom drain with anti-siphon trap.
- Strainer to capture contaminants in waste water stream.
- Electric waste water pump with foot activated switch to pump to remote drains (not available on Downflow).
- Optional OSHA biohazard labeled waste water container for use when drain is not available.
- Optional locking waste water compartment with cover to prevent spillage during transport (standard on Downflow models). Included OSHA biohazard labeled waste water tank.
- Optional on-board clean water tank with electric pump.

## SITE PREPARATION

The Safe KEEPER drying cabinet with floor drain is designed to eliminate the need for hard plumbing, drain traps or hard wiring. Downflow and standard models are uniquely sized to pass through standard doorways.

## WATER SUPPLY

- Hose location is exterior, right side, with 8' hose provided.
- Hose is configured for standard water faucet connection with female fitting.
- Standard tap water supply pressure recommended; greater pressure requires an optional water regulator.
- Never leave water connected when not in use.

## DRAIN

- A hard drain and trap are not required.
- The interior drain is flush with the chamber floor and employs gravity and an integrated power assist pump.
- Drain hose routes to standard sink, floor drain or container.

## ELECTRICAL

- Line cord provided with standard molded plug, NEMA 4-14P for quick connection to standard wall outlet, NEMA 5-15R.
- A separate breaker is recommended.
- Line cord location is at cabinet top.

## EXHAUST

- Ductless filter output through cabinet top.
- Optional 8" collar available with butterfly valve for external ducting.



**CONTENTS:**

- Product Overview (p.2)
- Design Features (p.3)
- Performance & Selection (p.4)
- Filtration Technology (p.5)
- Product Information (p.7)
- Specifications (p.8)
- Options & Accessories (p.12)

FDC-002M

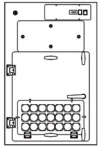

FDC-002

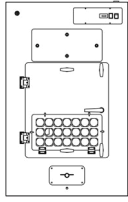

FDC-006GL

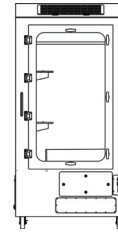

FDC-007GL

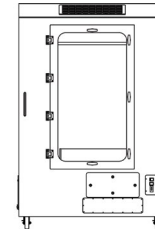

FDC-008GL

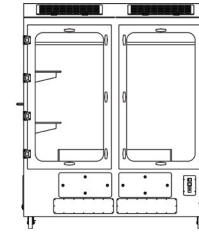

FDC-008DGL

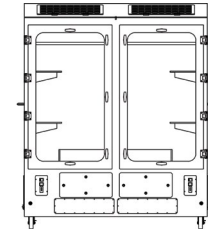

Side View



**SAFE KEEPER GENERAL PURPOSE**

MODEL	DIMENSIONS			WEIGHT (LBS/KG)	
	Internal Height	External (W × D × H)	Shipping (W × D × H)	Net	Ship

**Benchtop Models**

Safe KEEPER Benchtop models are sized to fit on a standard lab bench: the 19" high model fits on a 24" deep bench, the 24" high model fits on a 30" deep bench.

FDC-002M	18.375" / 465 mm	24" x 24" x 30" / 610 x 610 x 762 mm	40" x 40" x 40" / 1016 x 1016 x 1016 mm	68 / 31	118 / 54
FDC-002	18.375" / 465 mm	30" x 27.375" x 48" / 762 x 705 x 1219 mm	40" x 40" x 60" / 1016 x 1016 x 1524 mm	110 / 50	160 / 73

**Downflow Models**

Safe KEEPER Downflow Forensic Drying Cabinets, designed for use in a garage or parking area with dirty/sandy floors, feature activated carbon main filter formulated to capture putrid organic odors as well as other fumes such as alcohol, solvents, gasoline, etc.

**Standard Downflow Models**

FDC-006GL	45.25" / 1150 mm	36" x 27.75" x 73" / 914 x 705 x 1854 mm	40" x 40" x 88" / 1016 x 1016 x 2235 mm	229 / 104	273 / 124
FDC-007GL	45.25" / 1150 mm	48" x 27.75" x 73" / 1219 x 705 x 1854 mm	58" x 40" x 88" / 1473 x 1016 x 2235 mm	403 / 183	445 / 202
FDC-008GL	45.25" / 1150 mm	60" x 27.75" x 73" / 1524 x 705 x 1854 mm	65" x 40" x 88" / 1651 x 1016 x 2235 mm	471 / 214	520 / 236

**Duplex Downflow Model (2 chambers)**

FDC-008DGL	45.25" / 1150 mm	60" x 27.75" x 73" / 1524 x 705 x 1854 mm	65" x 40" x 88" / 1651 x 1016 x 2235 mm	485 / 220	530 / 241
------------	------------------	---	---	-----------	-----------



## CONTENTS:

- Product Overview (p.2)
- Design Features (p.3)
- Performance & Selection (p.4)
- Filtration Technology (p.5)
- Product Information (p.7)
- Specifications (p.8)
- Options & Accessories (p.12)

# SafeKEEPER®

SPECIFICATIONS

9

FDC-003

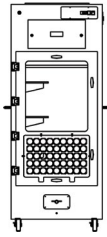

FDC-006

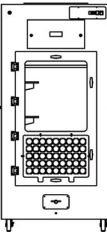

FDC-007

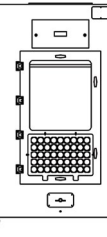

FDC-008

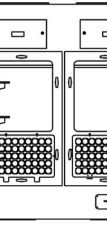

FDC-010

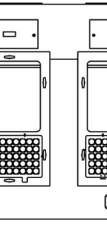

FDC-011

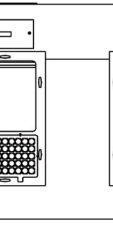

Standard



Tall

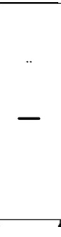

### SAFE KEEPER GENERAL PURPOSE: SINGLE CHAMBER

Safe KEEPER single chamber evidence drying cabinets include a single control system and single or dual filter/blower systems, depending on size; standard height cabinets on casters are designed to pass through standard doorways for maximum mobility, tall units are typically housed in a fixed location.

MODEL	DIMENSIONS			WEIGHT (LBS/KG)	
	Internal Height	External (W x D x H)	Shipping (W x D x H)	Net	Ship
<b>Standard Height Models (1 chamber)</b>					
FDC-003	45.25" / 1150 mm	30" x 27.75" x 74.375" / 762 x 705 x 1890 mm	40" x 40" x 89" / 1016 x 1016 x 2260 mm	213 / 97	245 / 111
FDC-006	45.25" / 1150 mm	36" x 27.75" x 74.375" / 914 x 705 x 1890 mm	40" x 40" x 89" / 1016 x 1016 x 2260 mm	229 / 104	273 / 124
FDC-006XL	45.25" / 1150 mm	39" x 27.75" x 74.375" / 991 x 705 x 1890 mm	45" x 40" x 89" / 1143 x 1016 x 2260 mm	258 / 117	302 / 137
FDC-007	45.25" / 1150 mm	48" x 27.75" x 74.375" / 1219 x 705 x 1890 mm	58" x 40" x 89" / 1473 x 1016 x 2260 mm	403 / 183	445 / 202
FDC-008	45.25" / 1150 mm	60" x 27.75" x 74.375" / 1524 x 705 x 1890 mm	65" x 40" x 89" / 1651 x 1016 x 2260 mm	471 / 214	520 / 236
FDC-010	45.25" / 1150 mm	72" x 27.75" x 74.375" / 1829 x 705 x 1890 mm	80" x 40" x 89" / 2032 x 1016 x 2260 mm	586 / 266	609 / 276
FDC-011	45.25" / 1150 mm	96" x 27.75" x 74.375" / 2438 x 705 x 1890 mm	106" x 40" x 89" / 2692 x 1016 x 2260 mm	670 / 304	715 / 324

#### Tall Models (1 chamber)

FDC-003XT	51.125" / 1300 mm	30" x 27.75" x 82.25" / 762 x 705 x 2090 mm	40" x 40" x 89" / 1016 x 1016 x 2260 mm	213 / 97	245 / 111
FDC-006XT	51.125" / 1300 mm	36" x 27.75" x 82.25" / 914 x 705 x 2090 mm	40" x 40" x 89" / 1016 x 1016 x 2260 mm	229 / 104	273 / 124
FDC-006XL-XT	51.125" / 1300 mm	39" x 27.75" x 82.25" / 991 x 705 x 2090 mm	45" x 40" x 89" / 1143 x 1016 x 2260 mm	258 / 117	302 / 137
FDC-007XT	51.125" / 1300 mm	48" x 27.75" x 82.25" / 1219 x 705 x 2090 mm	58" x 40" x 89" / 1473 x 1016 x 2260 mm	403 / 183	445 / 202
FDC-008XT	51.125" / 1300 mm	60" x 27.75" x 82.25" / 1524 x 705 x 2090 mm	65" x 40" x 89" / 1651 x 1016 x 2260 mm	471 / 214	520 / 236
FDC-010XT	51.125" / 1300 mm	72" x 27.75" x 82.25" / 1829 x 705 x 2090 mm	80" x 40" x 89" / 2032 x 1016 x 2260 mm	586 / 266	609 / 276
FDC-011XT	51.125" / 1300 mm	96" x 27.75" x 82.25" / 2438 x 705 x 2090 mm	106" x 40" x 89" / 2692 x 1016 x 2260 mm	670 / 304	715 / 324

Specifications are subject to change without notice or obligation on the part of Air Science. For questions contact Air Science.

**CONTENTS:**

- Product Overview (p.2)
- Design Features (p.3)
- Performance & Selection (p.4)
- Filtration Technology (p.5)
- Product Information (p.7)
- Specifications (p.8)
- Options & Accessories (p.12)

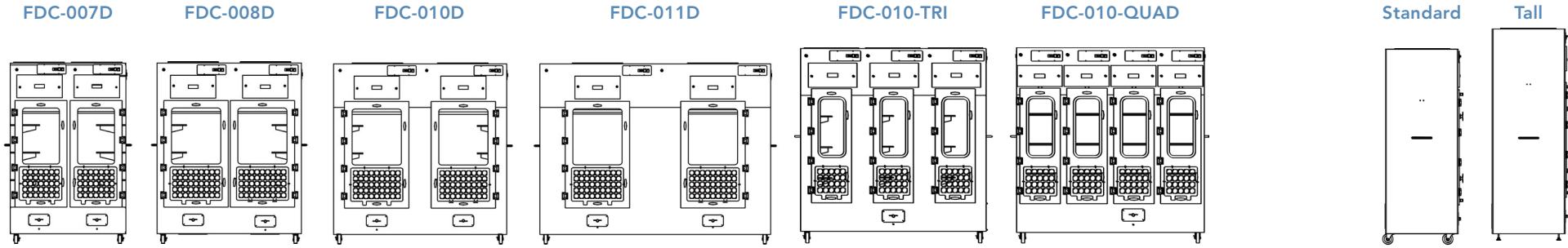

**SAFE KEEPER GENERAL PURPOSE: MULTI-CHAMBER**

Safe KEEPER General Purpose multiple chamber evidence drying cabinets feature independently filtered and controlled chambers within a single cabinet; Triplex and Quad models permit simultaneous but separated processing.

MODEL	DIMENSIONS			WEIGHT (LBS/KG)	
	Internal Height	External (W x D x H)	Shipping (W x D x H)	Net	Ship
<b>Standard Height Duplex Models (2 chambers)</b>					
FDC-007D	45.25" / 1150 mm	48" x 27.75" x 74.375" / 1219 x 705 x 1890 mm	58" x 40" x 89" / 1473 x 1016 x 2260 mm	451 / 205	502 / 228
FDC-008D	45.25" / 1150 mm	60" x 27.75" x 74.375" / 1524 x 705 x 1890 mm	65" x 40" x 89" / 1651 x 1016 x 2260 mm	485 / 220	530 / 241
FDC-010D	45.25" / 1150 mm	72" x 27.75" x 74.375" / 1829 x 705 x 1890 mm	80" x 40" x 89" / 2032 x 1016 x 2260 mm	601 / 273	623 / 283
FDC-011D	45.25" / 1150 mm	96" x 27.75" x 74.375" / 2438 x 705 x 1890 mm	106" x 40" x 89" / 2692 x 1016 x 2260 mm	715 / 324	760 / 345
<b>Tall Duplex Models (2 chambers)</b>					
FDC-007DXT	51.125" / 1300 mm	48" x 27.75" x 82.25" / 1219 x 705 x 2090 mm	58" x 40" x 89" / 1473 x 1016 x 2260 mm	451 / 205	502 / 228
FDC-008DXT	51.125" / 1300 mm	60" x 27.75" x 82.25" / 1524 x 705 x 2090 mm	65" x 40" x 89" / 1651 x 1016 x 2260 mm	485 / 220	530 / 241
FDC-010DXT	51.125" / 1300 mm	72" x 27.75" x 82.25" / 1829 x 705 x 2090 mm	80" x 40" x 89" / 2032 x 1016 x 2260 mm	601 / 273	623 / 283
FDC-011DXT	51.125" / 1300 mm	96" x 27.75" x 82.25" / 2438 x 705 x 2090 mm	106" x 40" x 89" / 2692 x 1016 x 2260 mm	715 / 324	760 / 345
<b>Triplex Models (3 chambers)</b>					
FDC-010-TRI	51.125" / 1300 mm	72" x 27.75" x 74.375" / 1829 x 705 x 1890 mm	80" x 40" x 89" / 2032 x 1016 x 2260 mm	689 / 313	739 / 335
<b>Quad Models (4 chambers)</b>					
FDC-010-QUAD	45.25" / 1150 mm	72" X 27.75" X 74.375" / 1829 X 705 X 1890 mm	80" x 40" x 89" / 2032 x 1016 x 2260 mm	723 / 328	773 / 351

Specifications are subject to change without notice or obligation on the part of Air Science. For questions contact Air Science.

**CONTENTS:**

- Product Overview (p.2)
- Design Features (p.3)
- Performance & Selection (p.4)
- Filtration Technology (p.5)
- Product Information (p.7)
- Specifications (p.8)
- Options & Accessories (p.12)

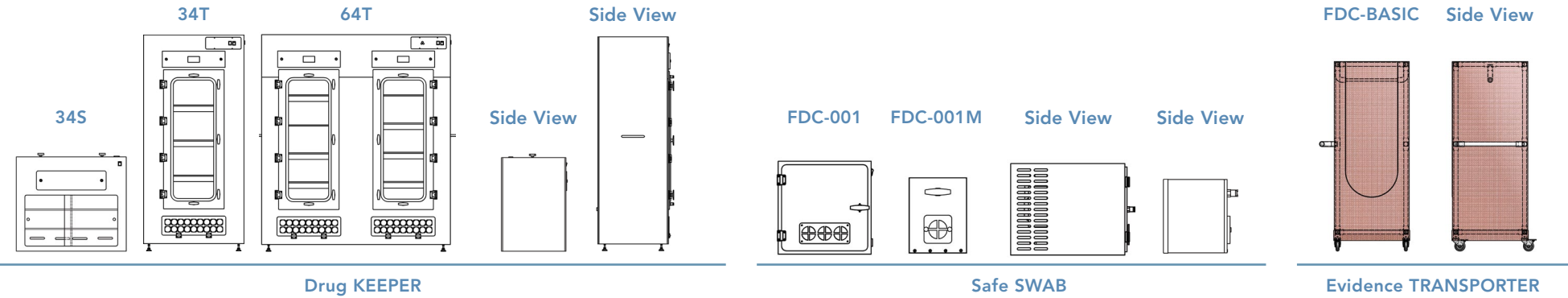

**SAFE KEEPER SPECIAL PURPOSE SERIES**

MODEL	DIMENSIONS			WEIGHT (LBS/KG)	
	Internal Height	External (W x D x H)	Shipping (W x D x H)	Net	Ship

**Drug KEEPER Models**

Drug KEEPER Storage Cabinets, useful for short-term storage of hazardous chemicals and other substances typically associated with drug investigations, minimize health and environmental risks when handling chemical vapors, residues, VOCs and other materials related to methamphetamine production.

34S	18.5" / 470 mm	34" x 20" x 29" / 864 x 508 x 737 mm	40" x 40" x 40" / 1016 x 1016 x 1016 mm	115 / 55	170 / 80
34T	49" / 1245 mm	34" x 24" x 79" / 864 x 610 x 2007 mm	40" x 40" x 87" / 1016 x 1016 x 2210 mm	229 / 104	273 / 124
64T	49" / 1245 mm	64" x 24" x 79" / 1624 x 610 x 2007 mm	80" x 40" x 87" / 2032 x 1016 x 2210 mm	586 / 266	609 / 276

**Safe SWAB Models**

Safe SWAB Swab Dryer safely dries evidence swabs while protecting them from cross-contamination using a HEPA main filter formulated to contain particles or biological material that may be present.

FDC-001	15.25" / 387 mm	16" x 20" x 16" / 406 x 508 x 406 mm	24" x 24" x 24" / 610 x 610 x 610 mm	18 / 8.2	25 / 11.4
FDC-001M	15.25" / 387 mm	7.5" x 8" x 9.5" / 191 x 204 x 242 mm	12" x 12" x 12" / 305 x 305 x 305 mm	9 / 4.1	14 / 6.4

**Evidence TRANSPORTER**

Safe KEEPER Mobile Evidence TRANSPORTER is designed to maintain the integrity and credibility of evidence collected in the field. Ships and stores knocked down for compact storage, quickly field assembled when needed; white PVC frame with Texilene™ mesh fabric conceals unsightly material from display, resistant to liquids and odors, easily cleaned.

FDC-BASIC	68" / 1727.25 mm	35" x 29" x 69" / 889 x 736 x 1753 mm	30" x 29" x 13" / 762 x 736 x 331 mm	34 / 16	38 / 18
-----------	------------------	---------------------------------------	--------------------------------------	---------	---------

**CONTENTS:**

Product Overview (p.2)

Design Features (p.3)

Performance &amp; Selection (p.4)

Filtration Technology (p.5)

Product Information (p.7)

Specifications (p.8)

Options &amp; Accessories (p.12)

## OPTIONS &amp; ACCESSORIES

Safe KEEPER Series		Models	Part
FSA/Autocal Controller*	The optional FSA/Autocal controller displays the airflow and offers limited detection of low concentrations of hydrocarbon, some gases and organic acids. Audio and visual alarms alert users to filter saturation and if the airflow reaches preset thresholds. An Hour Counter is also included.	General Purpose & Drug KEEPER	ADV-P
Monitair Controller*	The optional microprocessor controller monitors and displays cabinet operating parameters, airflow, containment and offers limited detection of low concentrations of hydrocarbon, some gases and organic acids. Emits audio and visual alerts if conditions become unsafe and are all displayed on a LCD screen. Not TUV compliant.	General Purpose & Drug KEEPER	MON-P
Evidence Drying and Collection Trays	Tray fits into bottom of cabinet for additional drying space and allows trace items to fall into it. Available in white or black.	General Purpose & Drug KEEPER	TRAY-FDC
Stainless Steel Leveling Feet	Adjustable leveling feet. Included on XT models.	General Purpose & Drug KEEPER	LEVEL-FDC
Locking Wheels	Non-marking heavy duty caster wheels. Included on standard height and Downflow models.	General Purpose & Drug KEEPER	WHEEL-FDC
Windowless Doors	Used in locations near public viewing areas to conceal cabinet contents.	All units	SDoor-FDC
Ducting Collar	Allows unit to be connected to ductwork for running in vented mode, ductless mode or both.	General Purpose & Drug KEEPER	EXCOLLAR-P10
Waste Water Container	Safe KEEPER cabinets have built-in contaminant containment compartments that adhere to Occupational Safety and Health Administration (OSHA) Standards 29 CFR 1910.1030 regarding bloodborne pathogens.	General Purpose & Drug KEEPER	CARBOX-FDC
Start-Up Supply Kit	The start-up kit provides everything required to safely operate and maintain a forensic evidence cabinet. Includes hangers, latex gloves, disinfectant spray, paper lining for collecting trace evidence, tamper proof seals and a set of pre-filters.	General Purpose & Drug KEEPER	STARTKIT-FDC
Internal Fluorescent Lamp*	Lamp in vapor proof housing. Included with Monitair option.	All but Basic model	LIGHT-FDC
UV Lamp**	Creates light emission conditions know to safely decontaminate interior surfaces. Includes a timer, door microswitch, fully closing front sash and UV filtering clear polycarbonate panels. The UV operation must comply with local codes and facility safety practices.	All units except Evidence TRANSPORTER	UV-FDC

\* Factory installed; specify when ordering.

\*\* Includes timer and door microswitch. Safety precautions must be followed.

**CONTENTS:**

- Product Overview (p.2)
- Design Features (p.3)
- Performance & Selection (p.4)
- Filtration Technology (p.5)
- Product Information (p.7)
- Specifications (p.8)
- Options & Accessories (p.12)

## WARRANTY

This product is protected by the Air Science Legacy Limited Lifetime Warranty™.



For details visit the [Warranty section](#) of our website.

## STANDARDS & COMPLIANCE

Quality Management Systems	ISO 9001: 2015
Electrical Safety	UL-C-61010-1 CAN/CSA C22.2 61010-1-12 EN 61010-1:2010 CE Mark
OSHA, Occupational Safety and Health Administration	OSHA Standard -29 CFR, Safety and Health Regulations for General Industry, 1910.1450: Occupational exposure to hazardous chemicals in laboratories. Part B, definition, laboratory type hood. This product may assist you with compliance or as part of your chemical hygiene plan. Please consult your Safety Officer and/or Industrial Hygienist.
Environment	ISO 14001: 2015 ENERGY STAR® Partner



The information contained in this manual and the accompanying product are copyrighted and all rights are reserved by Air Science. Air Science reserves the right to make periodic minor design changes without obligation to notify any person or entity of such change.



Schedule  
Contract # GS-07F5832P





# WolfLabs

**Pricing on any accessories shown can be found by keying the part number into the search box on our website.**

The specifications listed in this brochure are subject to change by the manufacturer and therefore cannot be guaranteed to be correct. If there are aspects of the specification that must be guaranteed, please provide these to our sales team so that details can be confirmed.

**[www.wolflabs.co.uk](http://www.wolflabs.co.uk)**

**Tel : 01759 301142**

**Fax : 01759 301143**

**[sales@wolflabs.co.uk](mailto:sales@wolflabs.co.uk)**

Please contact us if this literature doesn't answer all your questions.